



KONGSBERG



ES38-18/200-18C

#### KEY FEATURES

- Wide-band split-beam transducer for fishery and fishery research applications
- Nominal frequency  
Split-beam: 38 kHz  
Single-beam: 200 kHz
- Frequency range  
Single-beam: 190-230 kHz  
Split-beam: 35-45 kHz
- Depth rate is 20 m
- Beamwidths are 18°
- Max. transmit power  
Single-beam: 200 W  
Split-beam: 500 W
- Physical dimensions:  
Length: 416 mm  
Width: 172 mm  
Height: 94 mm

#### COMBI-SPLIT TRANSDUCER

### ES38-18/200-18C

The ES38-18/200-18C is a combined transducer operating at two frequencies. It has a large bandwidth designed for fishery and research applications. The transducer includes two different transducers, a single-beam and a three-sector split-beam transducer. These can be operated simultaneously. The beamwidth remains 18° for both split-beam and single-beam transducer operation. For the split-beam transducer the operating frequency is 38 kHz, for single-beam operation the operating frequency is 200 kHz.

The compact size and light weight of the transducer allows it to be mounted on a large variety of subsea platforms. The transducer is provided with a subsea cable having two different terminations. Option one provides an 8-pin male MCIL8M connector especially well suited for WBT Mini and EK80 Portable. Option two provides an open-ended cable.

#### Order information

To order the ES38-18/200-18C transducer contact your local dealer or use our website

<https://www.kongsberg.com/es38-18-200-18c>

#### Transducer

Order number:  
398445 transducer with open ended cable  
430161 transducer with 8-pin MCIL8M SubConn® termination

#### Included in all deliveries:

- Transducer with a 5 m cable with a subConn® connector or a 20 m open-ended cable.
- Test Report

**SIMRAD**  
By KONGSBERG

## 38 kHz split-beam transducer, typical figures

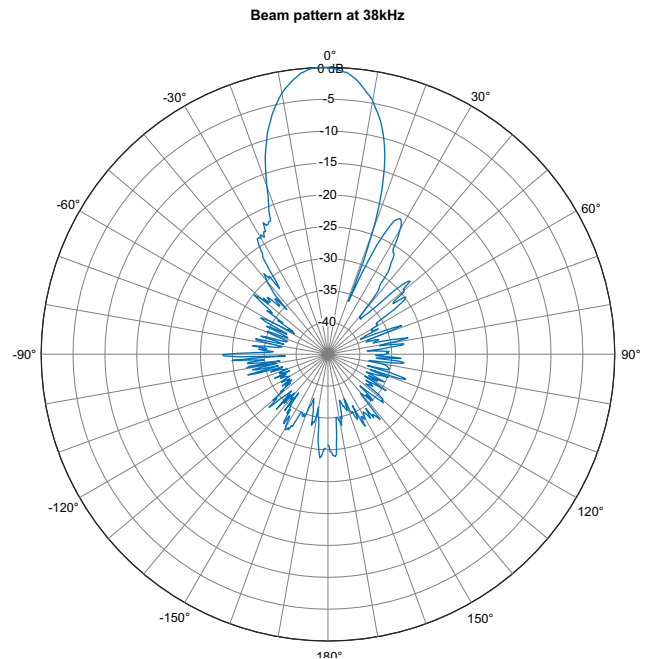
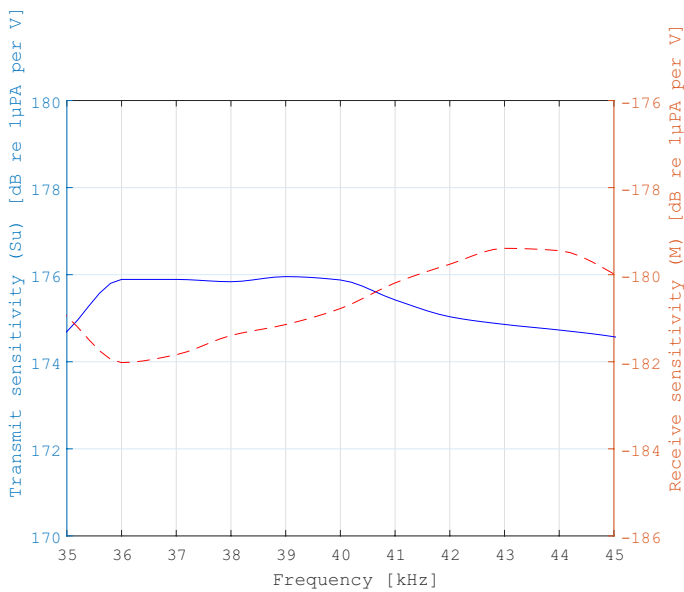
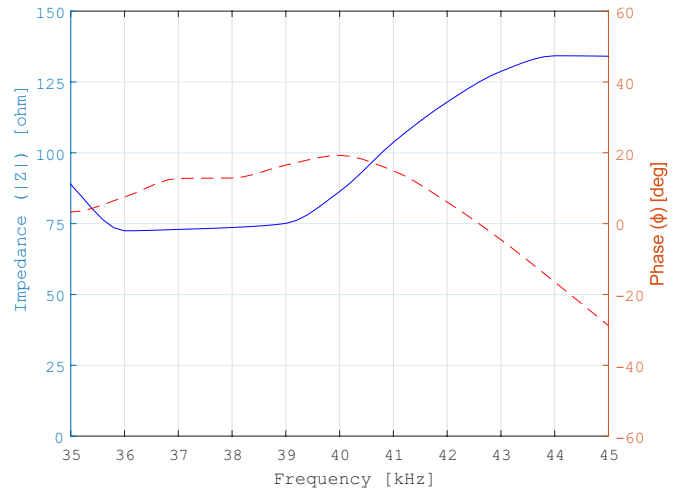
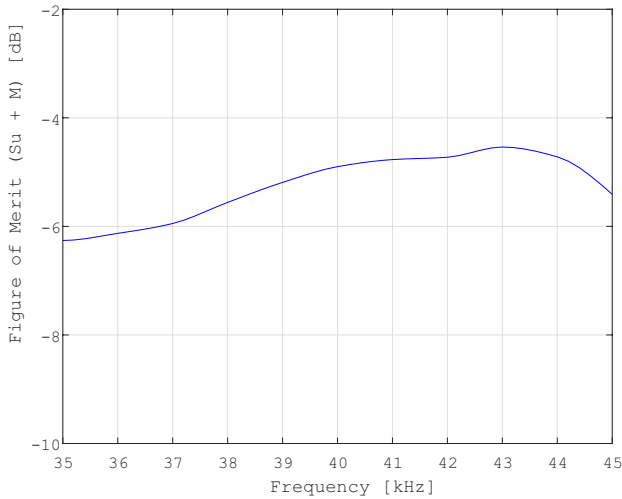

Beam pattern

### Technical specifications

The technical specifications and requirements provided are those valid when operating at the nominal frequency with all sectors excited simultaneously.

Kongsberg Maritime are continuously working to improve the quality and performance of our products. The technical specifications may be changed without prior notice and the specifications refers to typical figures for the product.

### Performance specifications

- Nominal frequency: 38 kHz
- Frequency range: 35 to 45 kHz
- Beamwidth: 18°
- Depth rating: 20 m

- Figure of merit: -6 dB
- Max. source level: 217 dB re  $\mu\text{Pa}$  per V @ 1 m
- Transmit sensitivity (Su): 176 dB re  $\mu\text{Pa}$  per V @ 1 m
- Receive sensitivity (Mt): -181 dB re 1 V per  $\mu\text{Pa}$  @ 1 m
- Sidelobe level: -18 dB
- Back radiation level: -25 dB
- Impedance (pr sector): 75  $\Omega$

### Power specifications

- Max. transmit power: 500 W
- Max. pulse length: 16 ms
- Max. duty cycle: 2 %

### Weight and outline dimensions

- Physical dimensions:  
Length: 416 mm
- Width: 172 mm

### Beam pattern

Height: 94 mm (body)

- Weight  
In air: 7,3kg (incl. cable)  
In water: 2,3 kg (incl. cable)
- Cable length with open ended termination: 20 m
- Cable length with 8-pin male SubConn® connector (MCIL8M) : 5 m
- Cable diameter: 10.4±0.5 mm
- Bending radius:  
Static: 100 mm (theoretical)  
Dynamic: 150 mm (theoretical)

### Environment requirements

- Storage temperature:  
Max.: +60°C  
Min.: -20°C
- Operating temperature:  
Max.: +40°C  
Min.: -5°C

## 200 kHz single-beam transducer, typical figures

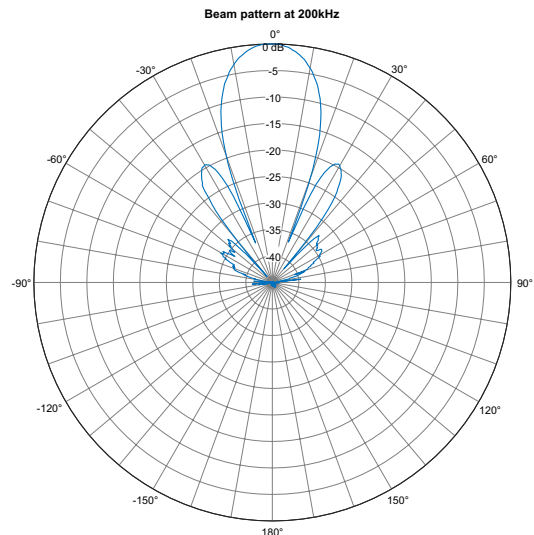
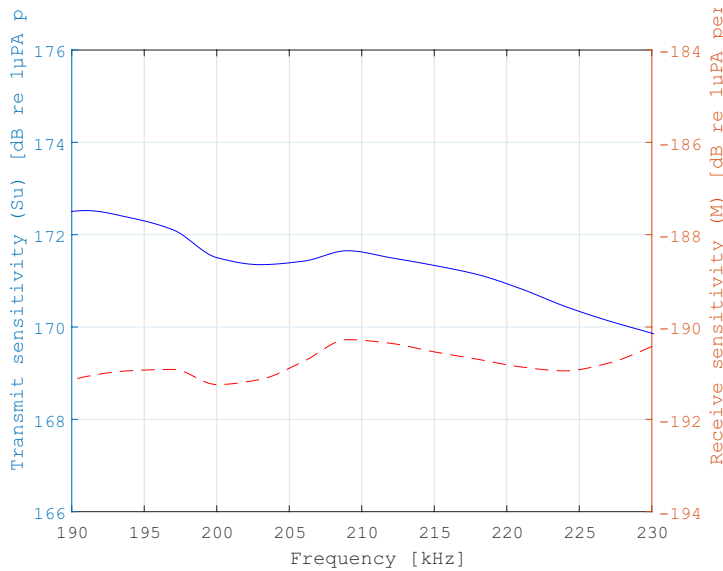
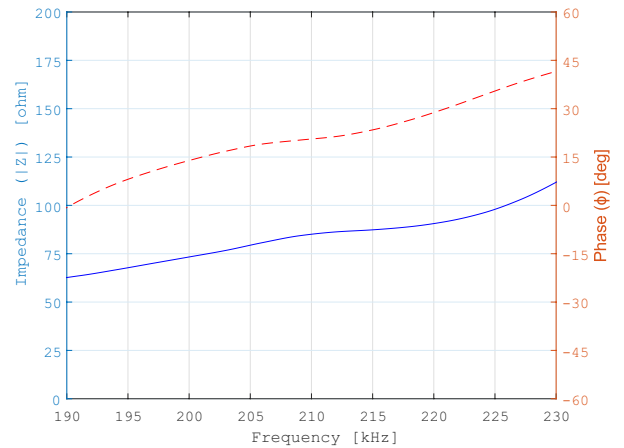
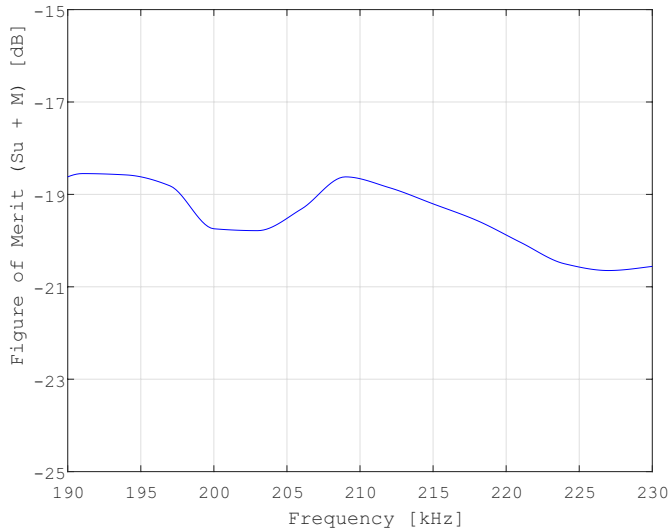

Beam pattern

### Technical specifications

The technical specifications and requirements provided are those valid when operating at the nominal frequency with all sectors excited simultaneously.

Kongsberg Maritime are continuously working to improve the quality and performance of our products. The technical specifications may be changed without prior notice and the specifications refers to typical figures for the product.

### Performance specifications

- Nominal frequency: 200 kHz
- Frequency range: 190 to 230 kHz
- Beamwidth: 18°
- Depth rating: 20 m
- Figure of merit: -20 dB
- Max. source level: 214 dB re  $\mu\text{Pa}$  per V

@ 1 m

- Transmit sensitivity (Su): 172 dB re  $\mu\text{Pa}$  per V @ 1 m
- Receive sensitivity (Mt): -191 dB re 1 V per  $\mu\text{Pa}$  @ 1 m
- Sidelobe level: -18 dB
- Back radiation level: -30 dB
- Impedance (each sector): 75  $\Omega$

### Power specifications

- Max. transmit power: 200 W
- Max. pulse length: 4 ms
- Max. duty cycle: 2 %

### Weight and outline dimensions

- Physical dimensions:
  - Length: 416 mm
  - Width: 172 mm
  - Height: 94 mm (body)
- Weight
  - In air: 7,3kg (incl. cable)

In water: 2,3 kg (incl. cable)

- Cable length with open ended termination: 20 m
- Cable length with 8-pin male SubConn® connector (MCIL8M) : 5 m
- Cable diameter: 10.4±0.5 mm
- Bending radius:
  - Static: 100 mm (theoretical)
  - Dynamic: 150 mm (theoretical)

### Environment requirements

- Storage temperature:
  - Max.: +60°C
  - Min.: -20°C
- Operating temperature:
  - Max.: +40°C
  - Min.: -5°C

## Rules for transducer handling

To secure the long life and accurate results, the transducer must be handled correctly.

A transducer must always be handled as a delicate item. Wrongful actions may damage the transducer beyond repair. Observe these transducer handling rules:

- Do not activate the transducer when it is out of the water.
- Do not handle the transducer roughly, avoid impacts.
- Do not expose the transducer to direct sunlight or excessive heat.
- Do not use high-pressure water, sand-blasting, metal tools, or strong solvents to clean the transducer face.
- Do not damage the outer protective skin on the transducer face.
- Do not lift the transducer by the cable.
- Do not step on the transducer cable.
- Do not damage the transducer cable, avoid sharp objects.

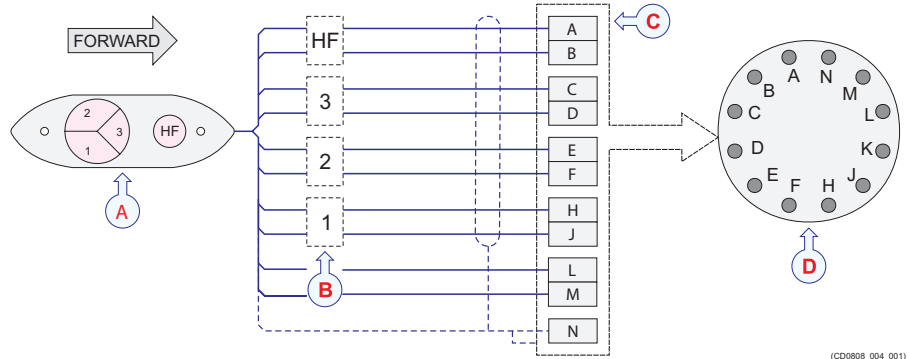

(CD0808\_004\_001)

## Connections to an Amphenol connector

The transducer comes with an open-ended cable as an option. This can connect to terminals A through N in a circular 12-pin Amphenol plug. This plug is used for the General Purpose Transceiver (GPT), and on some versions of the Wide Band Transceiver (WBT).

- (A) Transducer seen from top - observe the sector locations relative to the forward direction!
- (B) Sectors
- (C) Terminals
- (D) Transducer plug solder side

- Sector 1  
White cable to pin J  
Black cable to pin H
- Sector 2  
Green cable to pin F  
Black cable to pin E
- Sector 3  
Yellow cable to pin D  
Black cable to pin C
- Sector HF  
Blue cable to pin B  
Black cable to pin A
- Digital  
Red cable to pin L  
Black cable to pin M
- Cable screen to pin N

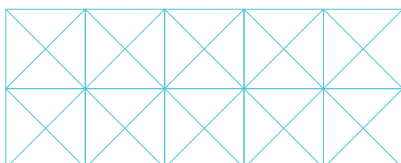
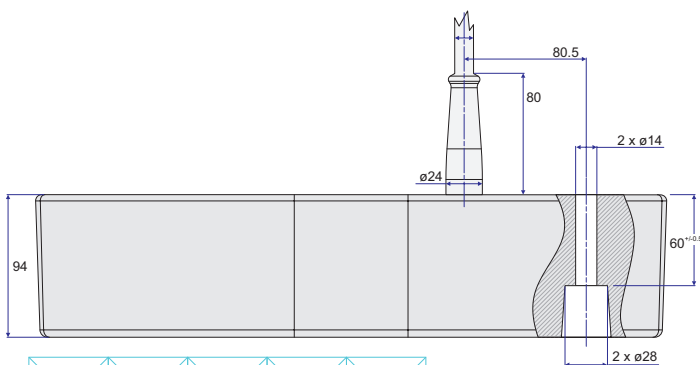
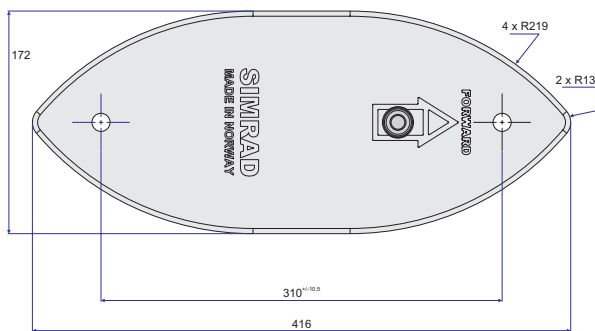

KONGSBERG MARITIME  
SIMRAD  
Strandpromenen 50  
P.O.Box 111  
kongsberg.com/simrad

## Connections

The transducer comes with a MacArtney MCIL8M connector. Pinout looking into the plug is shown in the figure to the right. Pins 1 through 6 on a circular 8-pin SubConn® socket are used. This socket is used for the WBAT, WBT Mini and WBT Tube (WideBand Transceiver).

- (A) Transducer seen from top - observe the sector locations relative to the forward direction!
- (B) Sectors
- (C) Terminals
- (D) Transducer connector face view



Switchboard: +47 815 73 700  
Global support 24/7: +47 33 03 24 07  
E-mail sales: km.sales@km.kongsberg.com  
E-mail support:  
simrad.support@simrad.com  
km.support.science@km.kongsberg.com